

Directional spool valve types

WMM6 hand lever operated

WMD6 rotary knob operated

WMR6 roller operated

WH6 hydraulically operated

**WK
420 170**

NS6

up to 31,5 MPa

up to 80 dm³/min

08.2008

APPLICATION

Directional spool valves are intended for change in direction of fluid flow in a hydraulic system and thus it allows to change direction of movement of a receiver - mostly piston rod of a cylinder or hydraulic motor as well to use functions: *on* and *off*.

Directional spool valves can be made in differently operated design versions:

- hand lever operated type **WMM6**
- rotary knob operated type **WMD6/WMDA6**
- roller operated type **WMR6/WMU6**
- hydraulically operated type **WH6**

The directional valves are intended for subplate mounting in any position in hydraulic system.



DESCRIPTION OF OPERATION

General information

Main bore and annular ports **P**, **T**, **A**, **B** are made in the housing (1) and connected to its subplate connection. Directional valve is switched by shifting the spool (2) into one end position. Various control functions result from the shape of control spool (2) which affects the change in configuration of the connections between ports **P**, **T**, **A** and **B** in the housing (1).

Directional spool valve - hand lever operated type **WMM6**

The spool (2) is shifted by changing the position of hand lever (3) by means of the pin (4). The spool return (2) to its rest position is secured by centering springs (6) – version ...WMM6...-12/... . Positions of the spool can be fixed by means of the detent (5) as well – version ...WMM6...-12/F... Directional spool valve may be equipped with the orifice (7) placed in port **P** – version ...WMM6-12/...B.

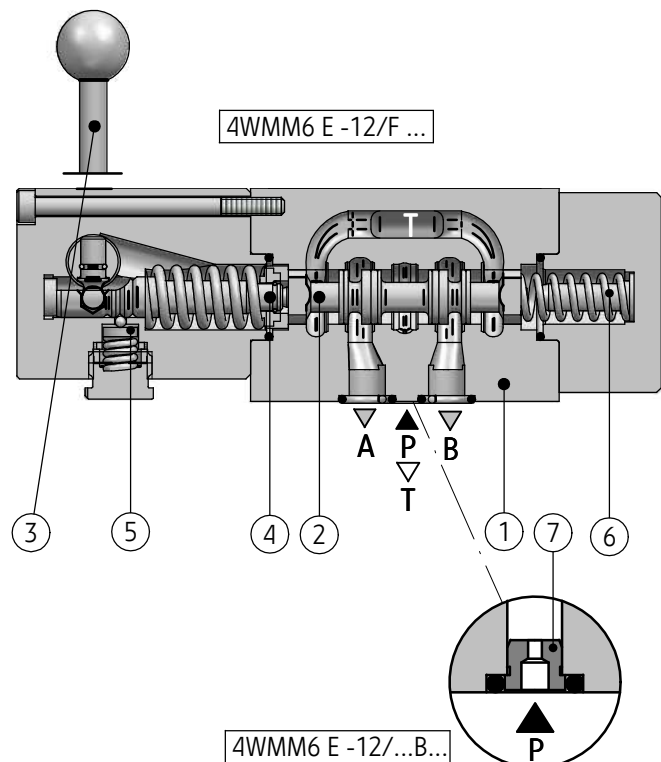

DESCRIPTION OF OPERATION

Directional spool valve - rotary knob operated type WMD6, WMDA6

The spool (2) is shifted by means of rotary knob (3) through the spindle (4) and by means of the spring (6). The spool is positioned by means of detent (5). Directional spool valve may be provided with orifice (7) placed in port P – version ...WMD6...-12/FB.

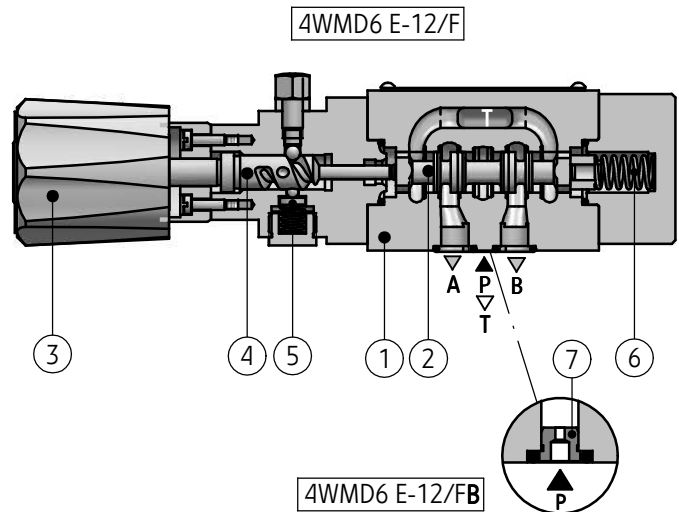

Directional spool valve - roller operated type WMR6/WMU6

The spool (2) is shifted by means of the pin (3) with the roller (4) at the end of pin, through the plunger (5). Spool return (2) to its rest position is secured by the spring (6). Directional spool valve may be provided with orifice (7) placed in port P – version ...WMR...-12/B.

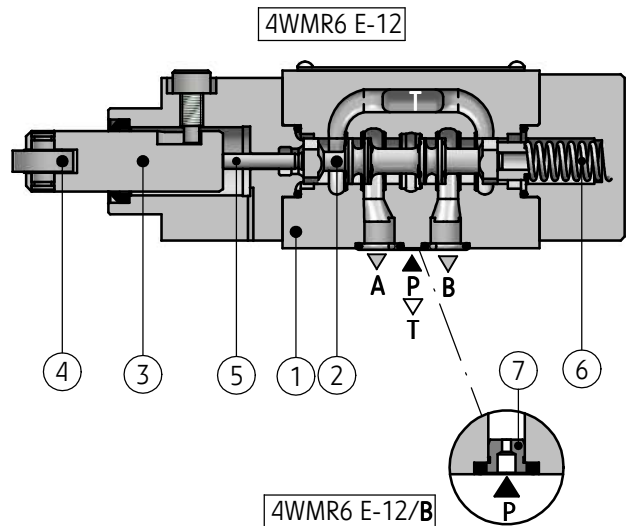

Directional spool valve -hydraulically operated type WH6

The spool (2) is shifted by means of the pressure supplied to connections of the caps (3) and thus it allows to move spools (4). Spool return (2) and its centering in neutral position (3-position directional valves) or fixing end positions (2-position directional valves) is secured by the springs (5) – version ...WH6...-12/...; hydraulically (with oil pressure) – version ...WH6...-12/O... or by means of detent – version ...WH6...-12/OF.... In versions: ...WH6...-12/O... and ...WH6...-12/OF... the spool position (4) is not fixed in case of the lack of supply. Directional spool valve may be provided with orifice (6) placed in port P – version ...WH6...-12/...B.

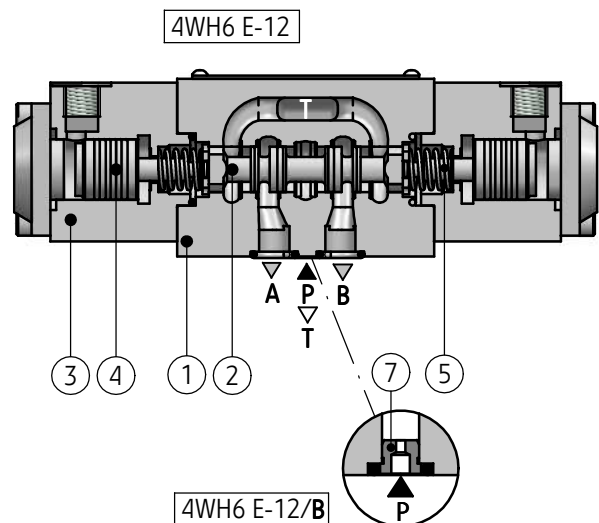

TECHNICAL DATA

Hydraulic fluid	mineral oil							
Required filtration	up to 16 µm							
Recommended filtration	up to 10 µm							
Nominal fluid viscosity	37 mm ² /s at temperature 55 °C							
Viscosity range	2,8 up to 380 mm ² /s							
Fluid temperature range (in a tank)	recommended	40°C up to 55°C						
	max	-20°C up to +70°C						
Ambient temperature range	- 20°C up to +70°C							
Features	type WMM6		type WMD6/WMDA6		type WMR6/WMU6		type WH6	
Max operating pressure	ports		ports		ports		ports	
	P, A, B	T	P, A, B	T	P, A, B	T	P, A, B	T
	31,5 MPa	16 MPa	31,5 MPa	16 MPa	31,5 MPa	6 MPa	31,5 MPa	16 MPa
Control pressure	—		—		—		min 0,6 - 1 MPa	
							max 20 MPa	
Switching force	pressure in port T				100 - 200 N			
	0 MPa	15 MPa	—				—	
	~ 20 N	~ 30 N						
Tightening torque of rotary knob	—		150 Ncm		—		—	
Max angle of control cam	—		—		30°		—	
Weight	1,4 kg		1,4 kg		1,4 kg		version with 2 control ports 1,8 kg	
							version with 1 control port 1,3 kg	
Flow section in 0 (central) position	spool Q - 6 % nominal section spool W - 3 % nominal section							

SCHEMES

Directional spool valve - hand lever operated type ...WMM6...-1X/...

Graphic symbols of 3-position directional spool valves

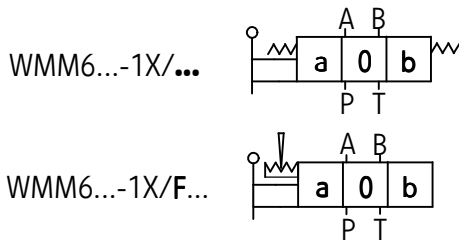

Graphic symbols of 2-position directional spool valves

versions with positions a, 0

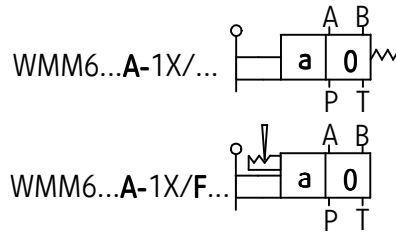

versions with positions 0, b

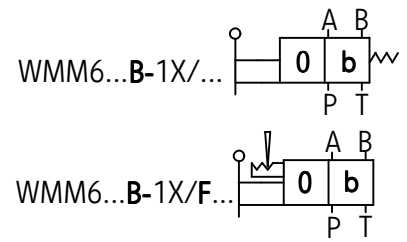

Graphic symbols of spools

working and indirect positions

working positions

working and indirect positions

working positions

working and indirect positions

working positions

working and indirect positions	working positions	working and indirect positions	working positions	working and indirect positions	working positions

NOTES:

The spool **E** has the version **E1** with indirect positions like for spool **P**.
Flow sections in **0** (central) position for spools: **Q** and **W**. according to technical data on page 3.

SCHEMES

Directional spool valve - hand lever operated type ...WMM6...-1X/...

Graphic symbols of 2-position
directional spool valves

versions with positions a, b

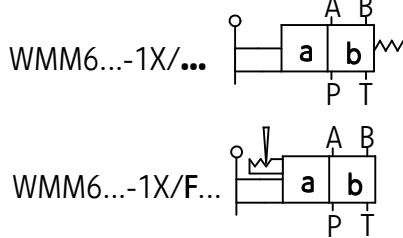

versions with positions a, b

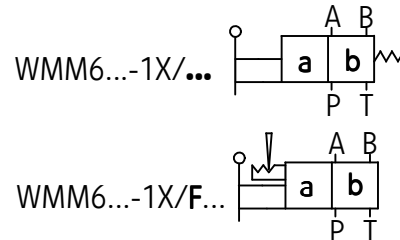

Graphic symbols of spools

working
and indirect
positions

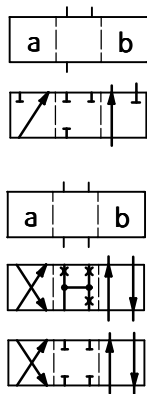

working
positions

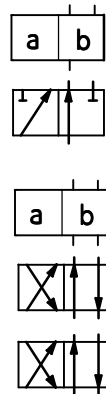

working
and indirect
positions

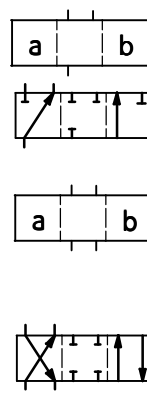

working
positions

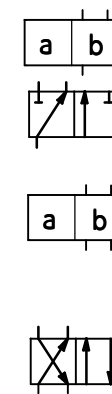

Directional spool valve - rotary knob operated type ...WMD6...-1X/... ; ...WMDA6...-1X/...

Graphic symbols of 2-position
directional spool valves

versions with positions a, b

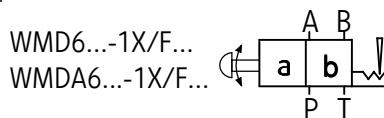

Graphic symbols of spools

working
and indirect
positions

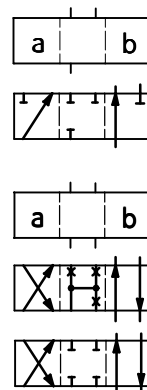

working
positions

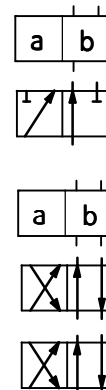

SCHEMES

Directional spool valve - rotary knob operated type ... WMD6...-1X/... ; ...WMDA6...-1X/...

Graphic symbols of 3-position directional spool valves

WMD6...-1X/F...
WMDA6...-1X/F...

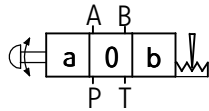

Graphic symbols of 2-position directional spool valves

versions with positions a, 0

WMD6...A-1X/F...
WMDA6...A-1X/F...

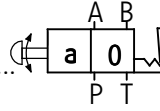

versions with positions 0, b

WMD6...B-1X/F...
WMDA6...B-1X/F...

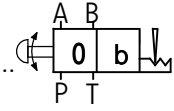

Graphic symbols of spools

working
and indirect
positions

working
positions

working
and indirect
positions

working
positions

working
and indirect
positions

working
positions

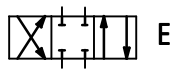
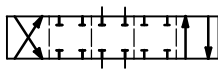
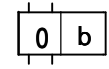
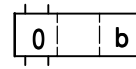
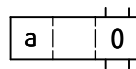
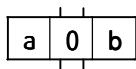
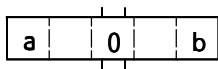

E

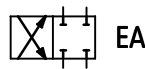

EA

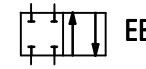
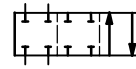

EB

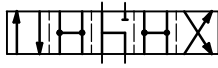

F

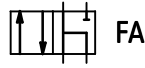

FA

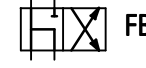

FB

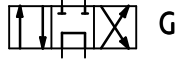
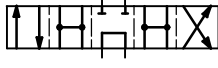

G

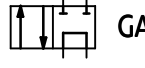

GA

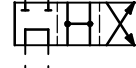

GB

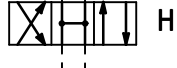

H

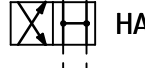

HA



HB

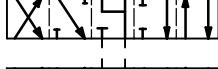

J

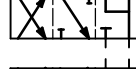

JA

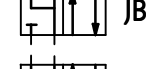

JB

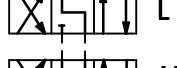

L

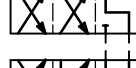

LA

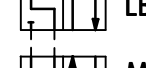
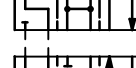

LB

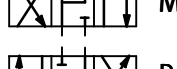
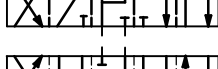

M

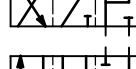

MA

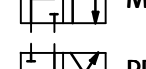

MB



P

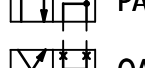

PA

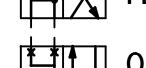

PB

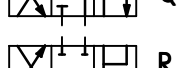
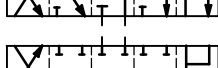

Q

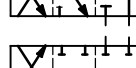

QA

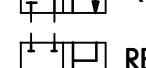

QB

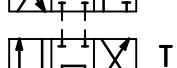
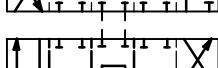

R

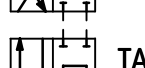
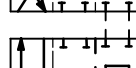

RA

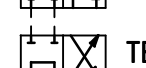

RB

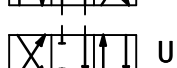

T

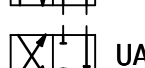
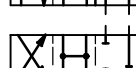

TA

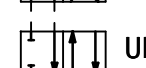

TB

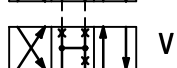
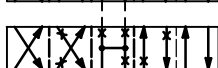

U



UA

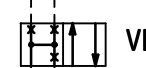
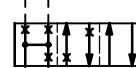

UB

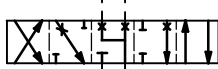

V

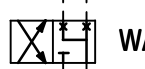

VA

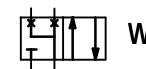
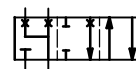

VB



W



WA



WB

NOTES:

The spool **E** has the version **E1** with indirect positions like for spool **P**.
Flow sections in **0** (central) position for spools: **Q** and **W** according to technical data on page 3.

SCHEMES

Directional spool valve - roller operated type ... WMR6...-1X/... ; ...WMU6...-1X/...

Graphic symbols of 3-position
directional spool valves

WMR6...-1X/...
WMU6...-1X/...

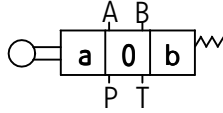

Graphic symbols of 2-position
directional spool valves

WMR6...-1X/...
WMU6...-1X/...

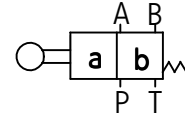

Graphic symbols of spools

working
and indirect
positions

working
positions

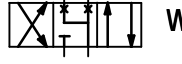
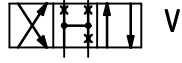
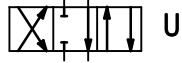
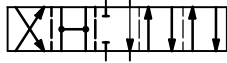
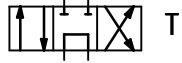
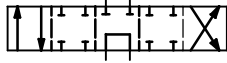
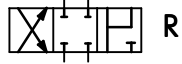
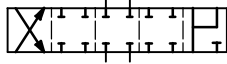
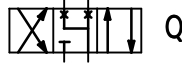
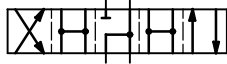
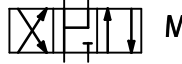
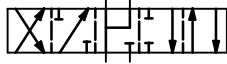
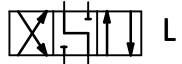
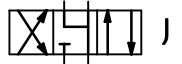
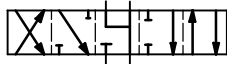
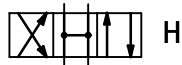
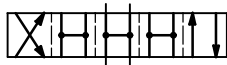
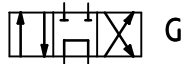
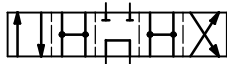
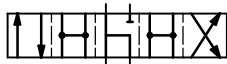
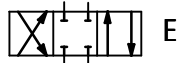
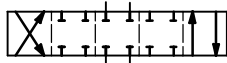
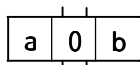
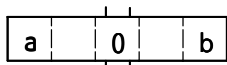

Graphic symbols of spools

working
and indirect
positions

working
positions

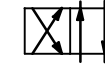
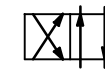
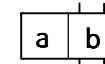
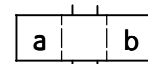
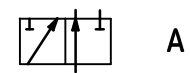
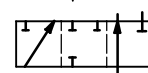
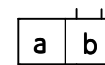
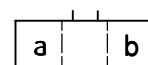

A

C

D

NOTES:

The spool **E** has the version **E1** with indirect positions like for spool **P**.
Flow sections in **0** (central) position for spools: **Q** and **W** according to
technical data on page 3.

SCHEMES

Directional spool valve - hydraulically operated type ...WH6...-1X/...

Graphic symbols of 3-position directional spool valves

WH6...-1X/...

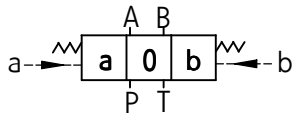

Graphic symbols of 2-position directional spool valves

versions with positions a, 0

WH6...A-1X/...

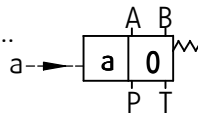

versions with positions 0, b

WH6...B-1X/...

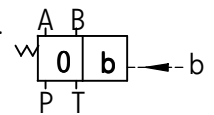

Graphic symbols of spools

working and indirect positions

working positions

working and indirect positions

working positions

working and indirect positions

working positions

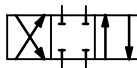
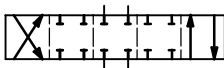
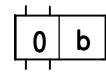
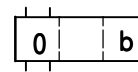
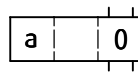
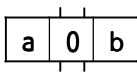
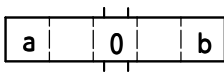

E



EA

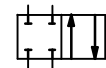
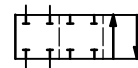

EB

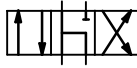

F



FA



FB

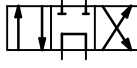
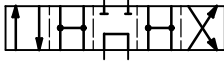

G



GA

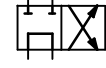
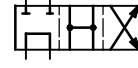

GB

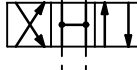

H



HA



HB

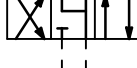
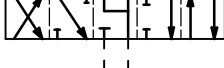

J

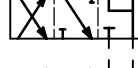

JA

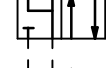
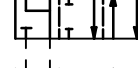

JB

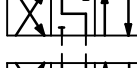
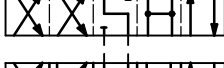

L

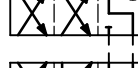

LA

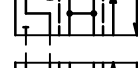

LB

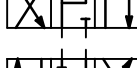
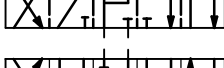

M

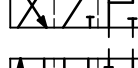

MA

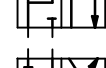
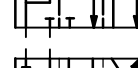

MB

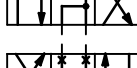

P

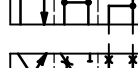

PA



PB

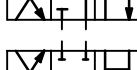
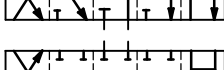

Q

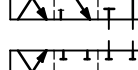

QA

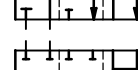

QB

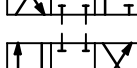
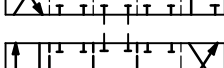

R



RA

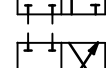
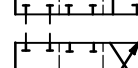

RB

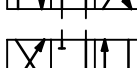
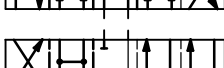

T

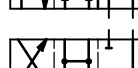

TA

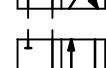

TB



U

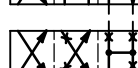

UA

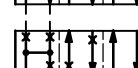

UB

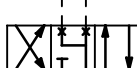
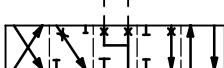

V

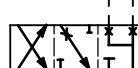

VA

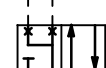
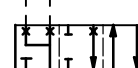

VB

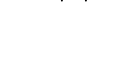

W



WA

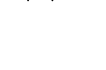

WB

NOTES:

The spool **E** has the version **E1** with indirect positions like for spool **P**.
Flow sections in **0** (central) position for spools: **Q** and **W**. according to technical data on page 3.

SCHEMES

Directional spool valve - hydraulically operated type ...WH6...-1X/...

Graphic symbols of 2-position directional spool valves

versions with positions **a, b**

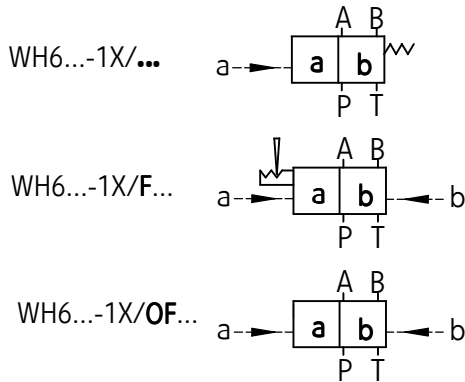

versions with positions **a, b**

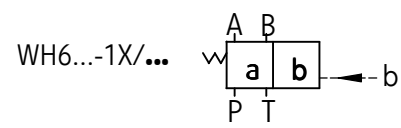

Graphic symbols of spools

working and indirect positions

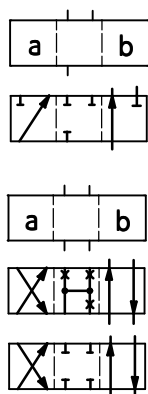

working positions

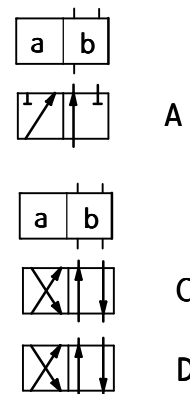

working and indirect positions

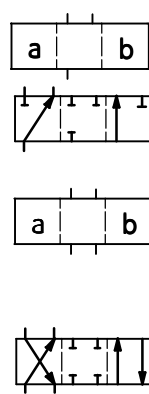

working positions

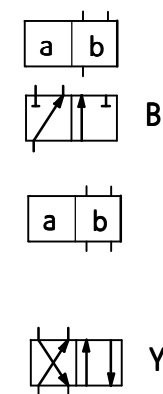

OVERALL AND CONNECTION DIMENSIONS

Directional spool valve - hand lever operated
type ...WMM6...-1X/...

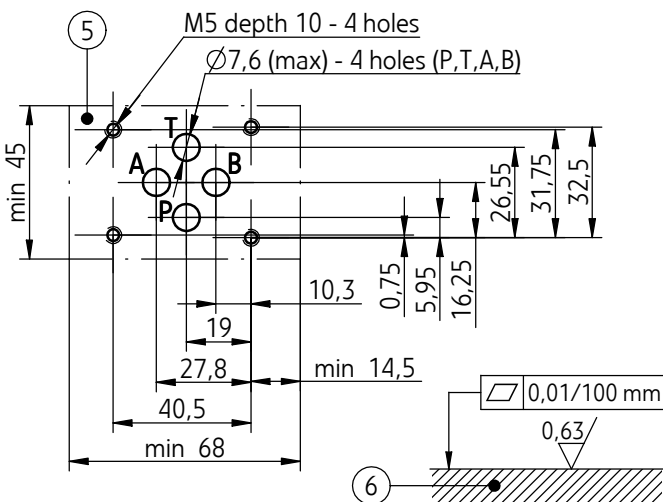
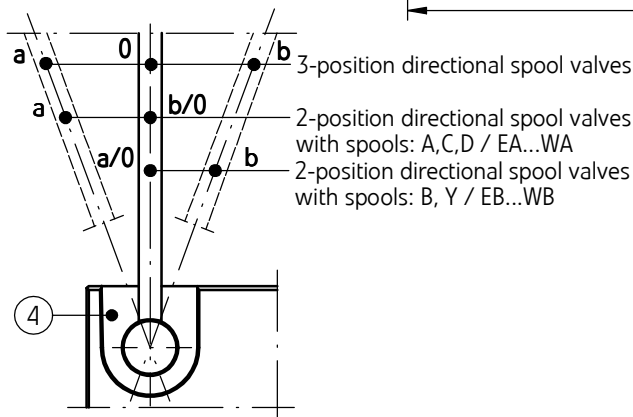
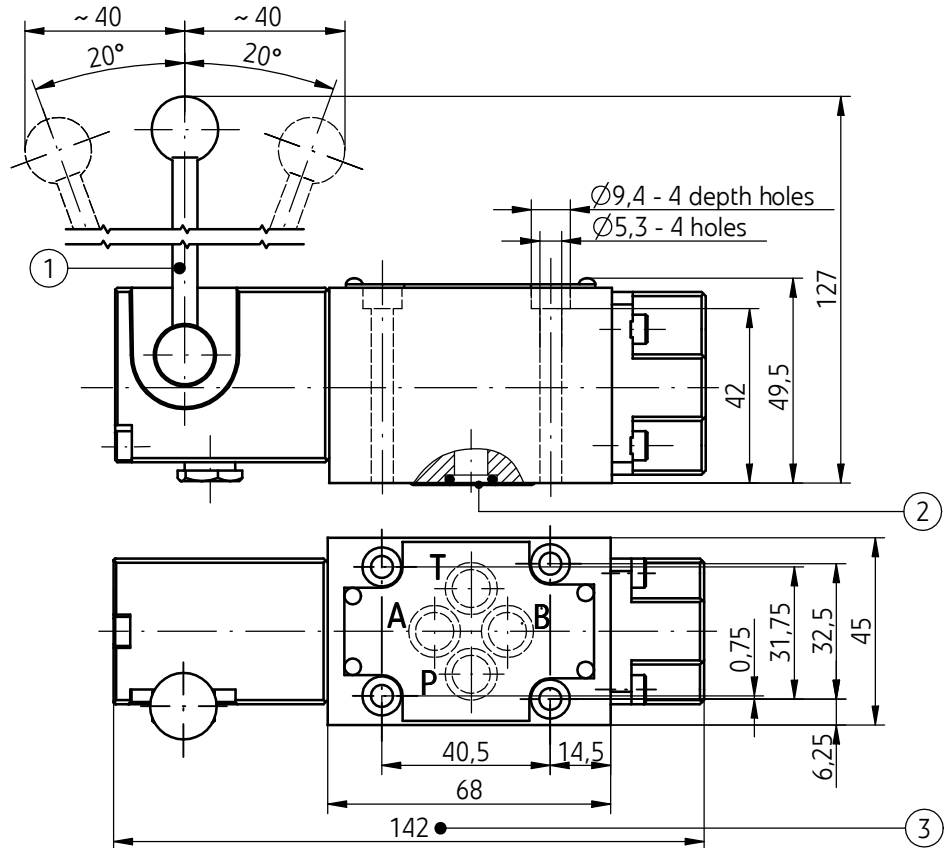

- 1 - Hand lever
- 2 - Sealing ring o-ring 9,2 x 1,8 - 4 pcs/kit (P,T,A,B)
- 3 - Overall dimension of directional spool valve:
 - 3-position directional spool valve springs centered
 - 3-position directional spool valve positioned with detent (spool schemes: E,F,G,H,J,L,M,Q,R,T,U,V,W - according to page 4)
 - 2-position directional spool valve positioned with return spring
 - 2-position directional spool valve positioned with detent (positions a, 0 - spool schemes: EA,FA,GA,HA,JA,LA,MA,PA,QA,RA,TA,UA,VA,WA - according to page 4) (positions 0, b - spool schemes: EB,FB,GB,HB,JB,LB,MB,PB,QB,RB,TB,UB,VB,WB - according to page 4) (positions a, b - spool schemes: A,C,D,B,Y - according to page 5)
- 4 - Positions of hand lever for different versions of directional spool valves
- 5 - Porting pattern - configuration of connection holes in subplate in accordance with the following standards:
 - ISO 4401 - identified by ISO 4401-03-02-0-94
 - CETOP RP 121H - identified by CETOP 4.2-4-03-320 (nominal size CETOP 03)
 mounting bolts M5 x 50 -10.9 in accordance with PN -EN ISO 4762 - 4 pcs/kit, tightening torque $Md = 9 Nm$
- 6 - Subplate surface required

OVERALL AND CONNECTION DIMENSIONS

Directional spool valve - rotary knob operated
type ... WMD6...-1X/... ; ...WMDA6...-1X/...

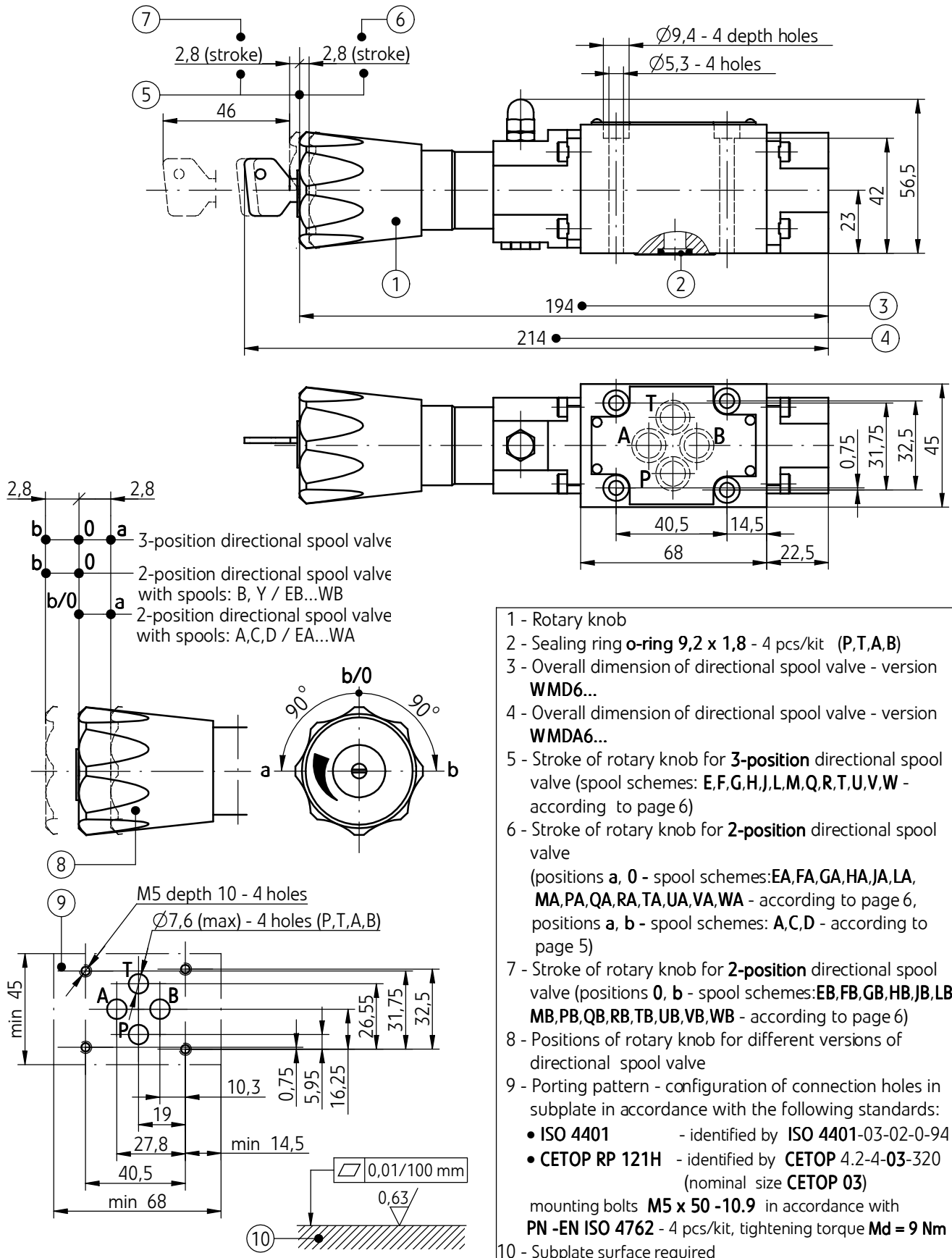

OVERALL AND CONNECTION DIMENSIONS

Directional spool valve - roller operated
type ... **WMR6...-1X/...** ; ...**WMU6...-1X/...**

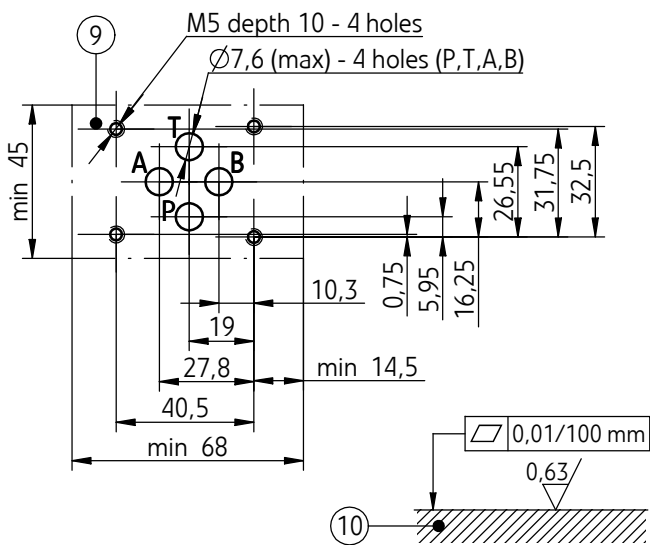
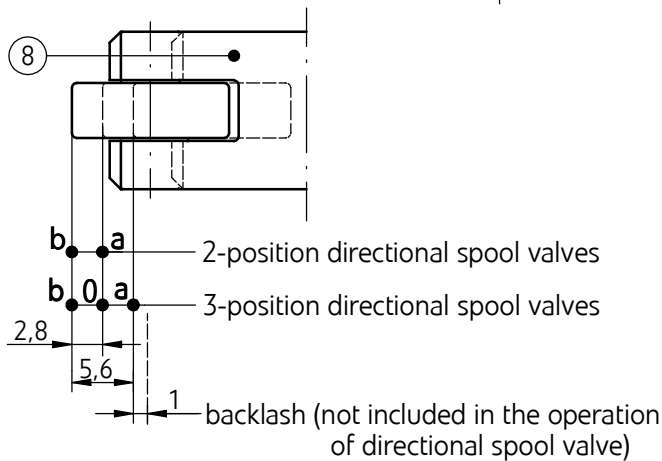
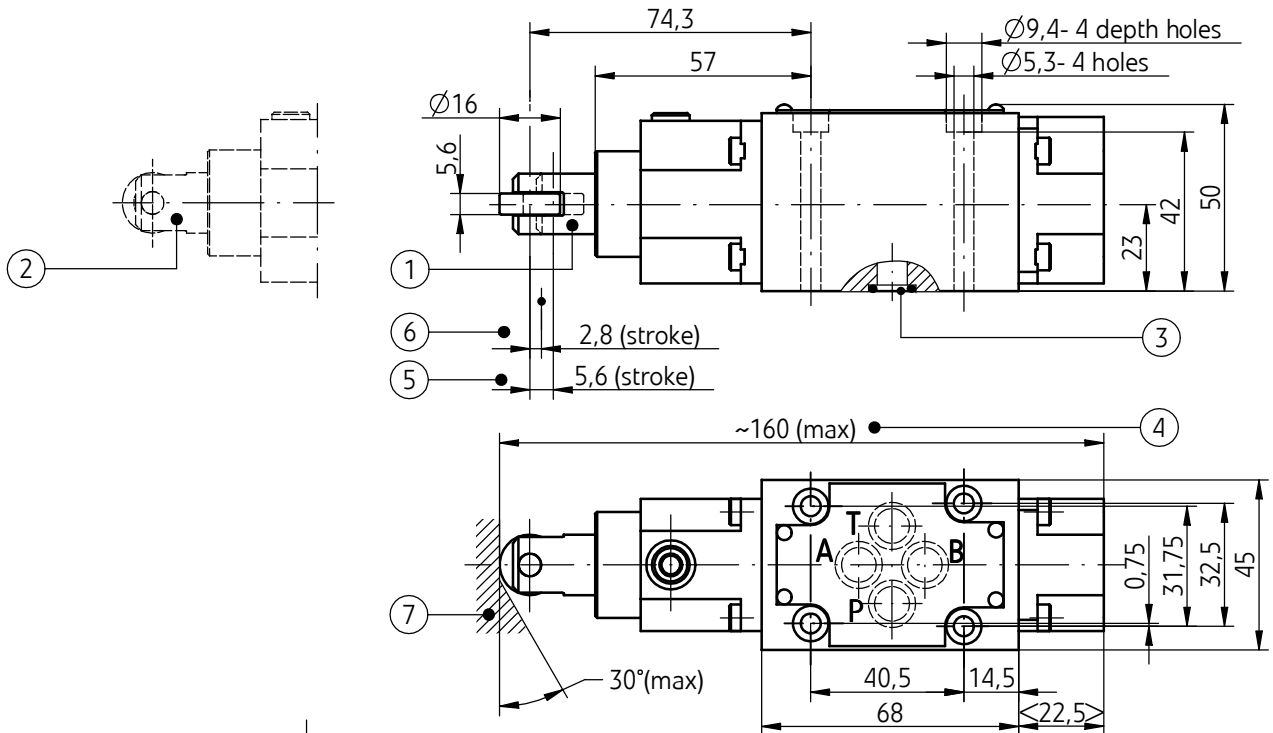

- 1 - Pin with roller - position for directional spool valve type **WMR6...**
 - 2 - Pin with roller - position for directional spool valve type **WMU6...**
 - 3 - Sealing ring **o-ring 9,2 x 1,8** - 4 pcs/kit (**P,T,A,B**)
 - 4 - Overall dimension of directional spool valves:
 - type **WMR6...** (2 and 3-position versions)
 - type **WMU6...** (2 and 3-position versions)
 - 5 - Stroke of roller for **3-position directional spool valve** (spool schemes: **E,F,G,H,I,L,M,Q,R,T,U,V,W** - according to page 7)
 - 6 - Stroke of roller for **2-position directional spool valve** (spool schemes: **A,C,D** - according to page 7)
 - 7 - Max angle of control cam
 - 8 - Position of pin with roller for different versions of directional spool valves (type **WMR6...** and **WMU6...**)
 - 9 - Porting pattern - configuration of connection holes in subplate in accordance with the following standards:
 - **ISO 4401** - identified by **ISO 4401-03-02-0-94**
 - **CETOP RP 121H** - identified by **CETOP 4.2-4-03-320** (nominal size **CETOP 03**)
- mounting bolts **M5 x 50 -10.9** in accordance with **PN -EN ISO 4762** - 4 pcs/kit, tightening torque **Md = 9 Nm**

10 -Subplate surface required

OVERALL AND CONNECTION DIMENSIONS

Directional spool valve - hydraulically operated
type ...WH6...-1X/...

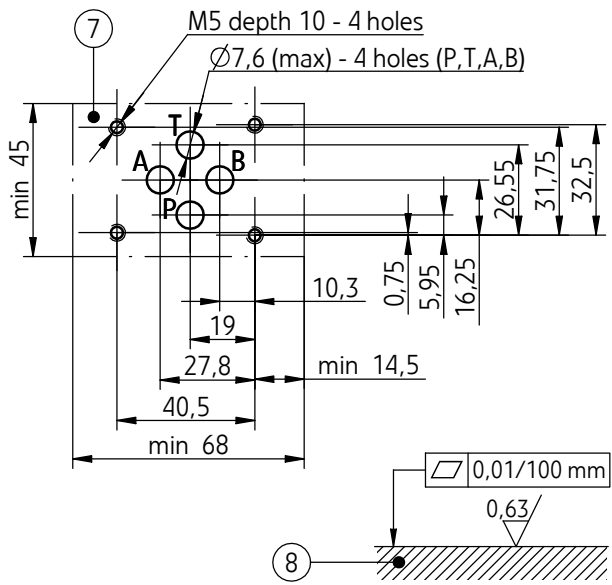
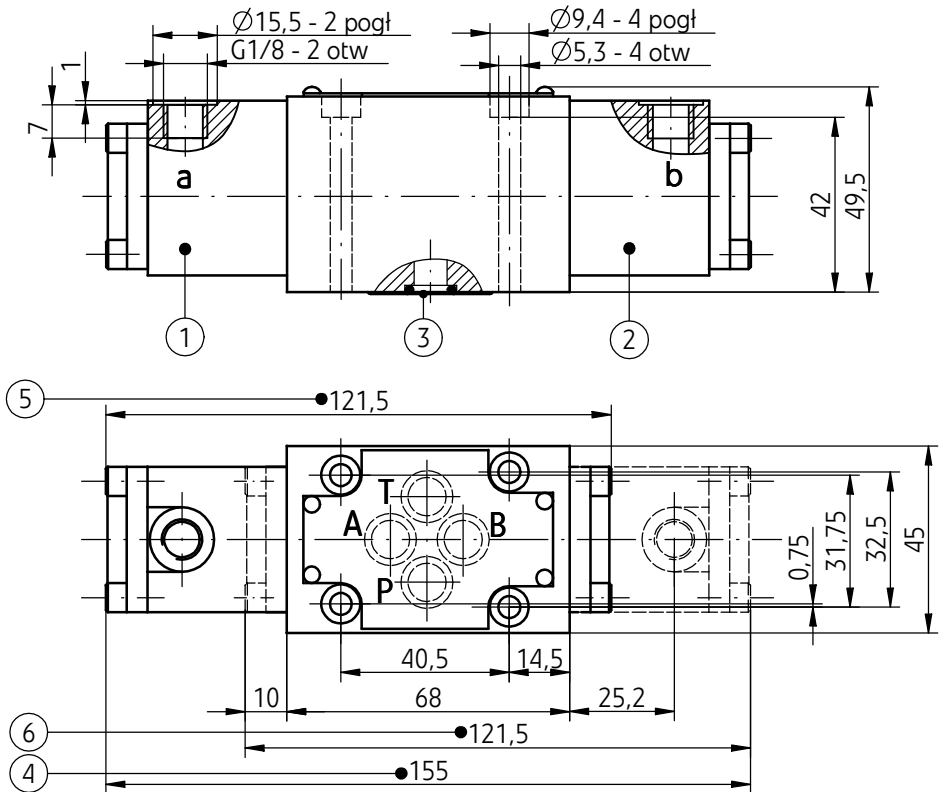

- 1 - Cap with control port **a**
- 2 - Cap with control port **b**
- 3 - Sealing ring **o-ring 9,2 x 1,8** - 4 pcs/kit (**P,T,A,B**)
- 4 - Overall dimension of directional spool valve:
 - **3-position directional spool valve springs centered d** (spool schemes: **E,F,G,H,I,L,M,Q,R,T,U,V,W** - according to page 8)
 - **2-position directional spool valve without return springs and without detent**
 - **2-position directional spool valve without return springs and with detent** (positions: **a, b** - spool schemes: **A,C,D** - according to page 9)
- 5 - Overall dimension of directional spool valve:
 - **2-position directional spool valve spring positioned** (positions **a, b** - spool schemes: **A,C,D** - according to page 9, positions: **a, 0** - spool schemes: **EA,FA,GA,HA,JA,LA,MA,PA,QA,RA,TA,UA,VA,WA** according to page 8)
- 6 - Overall dimension of directional spool valve:
 - **2-position directional spool valve spring positioned** (positions: **a, b** - spool schemes: **B, Y** - according to page 9, positions: **0, b** - spool schemes: **EB,FB,GB,HB,I,B,LB,MB,PB,QB,RB,TB,UB,VB,WB** - according to page 8)
- 7 - Porting pattern - configuration of connection holes in subplate in accordance with the following standards:
 - **ISO 4401** - identified by **ISO 4401-03-02-0-94**
 - **CETOP RP 121H** - identified by **CETOP 4.2-4-03-320** (nominal size **CETOP 03**)
 mounting bolts **M5 x 50 - 10.9** in accordance with **PN-EN ISO 4762** - 4 pcs/kit, tightening torque **Md = 9 Nm**
- 8 - Subplate surface required

PERFORMANCE CURVES

measured at viscosity $\nu = 41 \text{ mm}^2/\text{s}$ and temperature $t = 50^\circ\text{C}$

Flow resistance curves

- type WMM6...; WMM6.../F...
- type WMD6.../F...; WMDA6.../F...
- type WMR6...; WMU6...
- type WH6...; WH6.../O...; WH6.../OF...

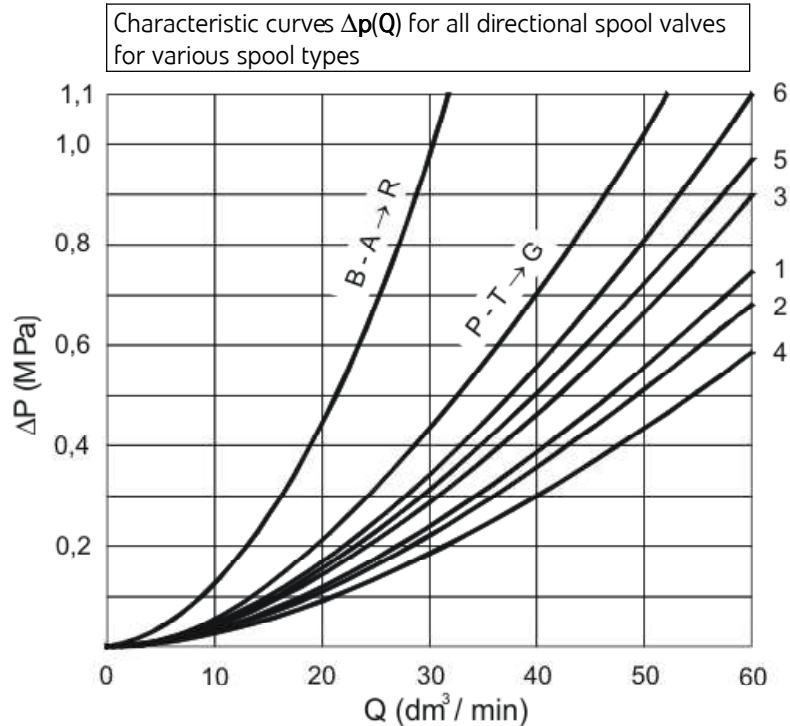

	A	B	C	D	E	F	G	H	J	L	M	P	Q	R	T	U	V	W	Y
P - A	3	3	1	5	3	2	5	2	1	1	2	2	1	5	5	3	1	1	5
P - B	3	3	1	5	3	3	3	4	1	1	4	3	1	5	3	1	2	1	5
A - T	-	-	3	3	1	3	6	2	2	2	3	3	2	4	6	3	1	2	3
B - T	-	-	1	3	1	5	6	2	1	2	3	5	1		6	3	1	2	3

Flow limits curves

- type WMM6 ...

Flow curves $p-Q$ for directional spool valve type WMM6 ... - versions with various spools springs centered

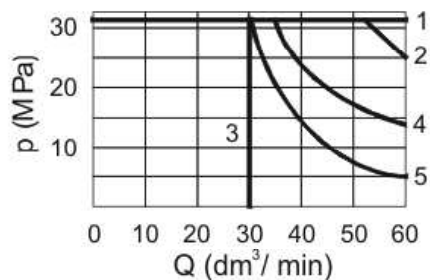

1	2	3	4	5
E1, M, E, J, L, Q, U, W, C, D, Y, G, H, R	A, B	V	F, P	T

PERFORMANCE CURVES

measured at viscosity $\nu = 41 \text{ mm}^2/\text{s}$ and temperature $t = 50^\circ\text{C}$

Flow limits curves

- type WMM6.../F...

Flow curves **p-Q** for directional spool valve type WMM6.../F... - versions with various spools positioned with detent

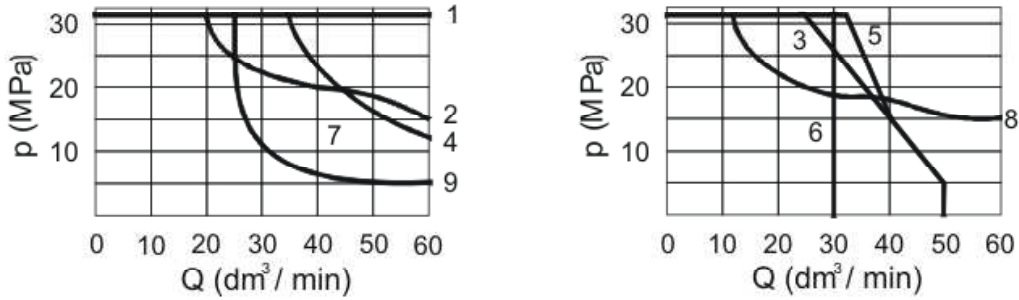

1	2	3	4	5	6	7	8	9
E1, M, H, C, D, Y	E, J, Q, L, U, W	A, B	G, T	F	V	P	R	T

- type WMD6.../F...
- type WMDA6.../F...

Flow curves **p-Q** for directional spool valve type: WMD6.../F...; WMDA6.../F... versions with various spools positioned with detent

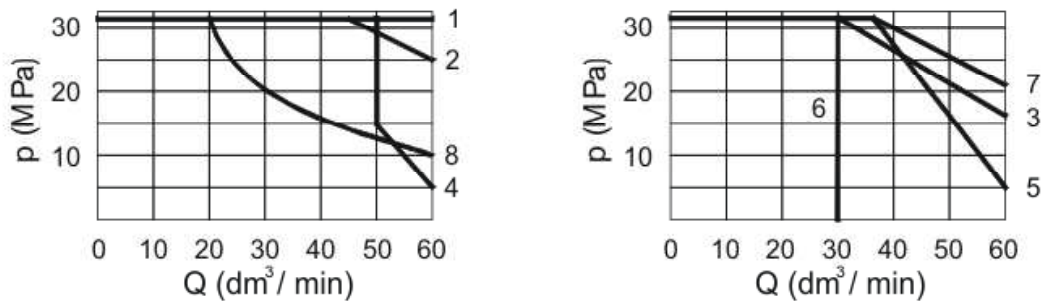

1	2	3	4	5	6	7	8
E1, M, H, C, D, E, Q, U, W	J, L	A	G, P	F	V	R	T

PERFORMANCE CURVES

measured at viscosity $\nu = 41 \text{ mm}^2/\text{s}$ and temperature $t = 50^\circ\text{C}$

Flow limits curves

- type WMR6...
- type WMU6...

Flow curves p-Q for directional spool valve type: WMR6...; WMU6... - versions with various spools springs centered

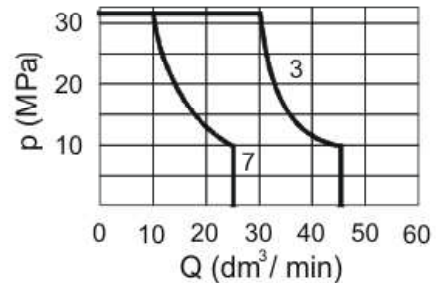
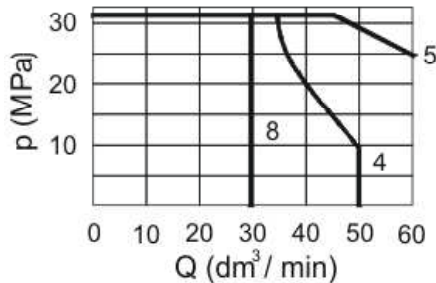

1	2	3	4	5	6	7	8
A	C, D, E, E1, H, M, Q, U, W	F, P	G	J, L	R	T	V

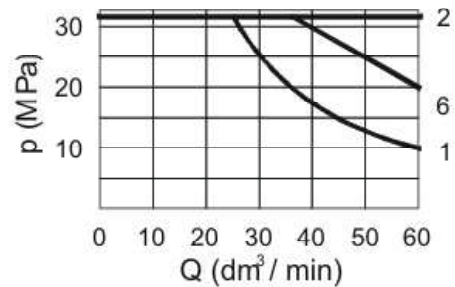

- type WH6...
- type WH6.../O...
- type WH6.../OF...

Flow curves p-Q for directional spool valve type: WH6 ...; WH6.../O...; WH6.../OF... versions with spools springs centered, positioned with detent and without detent

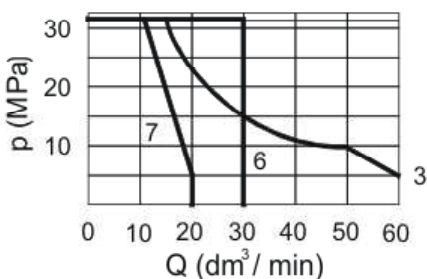
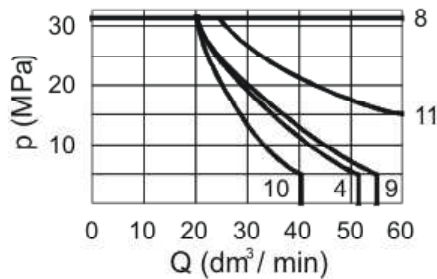
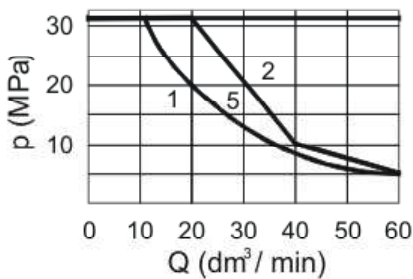

p = 0,6 MPa		p = 1 MPa	
1	A, B	1	A, B
2	C, D, Y	8	C, D, Y, E, G, H, J
3	E, J, L, U, M, Q, V, W	8	L, U, M, Q, V, W
4	F, E	9	F, P
5	T	10	R
6	G, H	11	T
7	P	-	-
8	A/O, C/O, D/O	8	A/O, C/O, D/O, A/OF, C/OF, D/OF

HOW TO ORDER

		6	+	/			*
--	--	----------	---	---	--	--	---

Number of service ports

3-way - for spools A, B = **3**
4-way - for the other spools = **4**

Type of operation

hand lever operated = **WMM**
 rotary knob operated = **WMD**
 lockable rotary knob operated = **WMDA**
 roller operated (roller positioning according to page12) = **WMR**
 roller operated (roller positioning according to page12) = **WMU**
 hydraulically operated = **WH**

Nominal size (NS)

NS6 = **6**

Spool type

spool schemes for directional spool valve:

type **WMM** - according to page **4, 5**
 type **WMD/WMDA** - according to page **5, 6**
 type **WMR/ WMU** - according to page **7**
 type **WH** - according to page **8, 9**

Series number

(10-19) - connection and installation dimensions unchanged = **1X**
series 12 = **12**

Spool positioning

spring centering - possible for directional spool valves type: **MM, WMR/WMU, WH** = **no designation**
with detent - possible for directional spool valves type: **WMM, WMD/WMDA** = **F**
 without return springs, without detent - possible for directional spool valves type **WH** = **0**
 without return springs, with detent - possible for directional spool valves type **WH** = **OF**

Throttle insert (in port P)

without throttle insert = **no designation**
 throttle insert ϕ 0,8 = **B 08**
 throttle insert ϕ 1,0 = **B 10**
 throttle insert ϕ 1,2 = **B 12**

Sealing

NBR (for fluids on mineral oil base) = **no designation**
FPM (for fluids on phosphate ester base) = **V**

Further requirements in clear text (to be agreed with the manufacturer)

NOTES:

Directional spool valve should be ordered according to the above coding.

The symbols in bold are preferred versions in short delivery time.

Coding examples: 4WMM6 E -12/B08; 4WMD6 E -12/F B08; 4WMR6 E -12/B08; 4WH6 E -12/B08

SUBPLATES AND MOUNTING BOLTS

Subplates must be ordered according to the data sheet
WK 496 480. Subplates:

G 341/01 - threaded connection G 1/4

G 342/01 - threaded connection G 3/8

G 502/01 - threaded connection G1/2

G 341/02 - threaded connection M14 x1,5

G 342/02 - threaded connection M16 x1,5

Subplates and fixing bolts **M5 x 50 - 10,9**
 in accordance with **PN -EN ISO 4762** - 4 pcs/kit)
must be ordered separately.

Tightening torque for bolts **Md = 9 Nm**

EXAMPLE OF APPLICATION IN HYDRAULIC SYSTEM

**Directional spool valve - hand lever operated
 type WMM6**

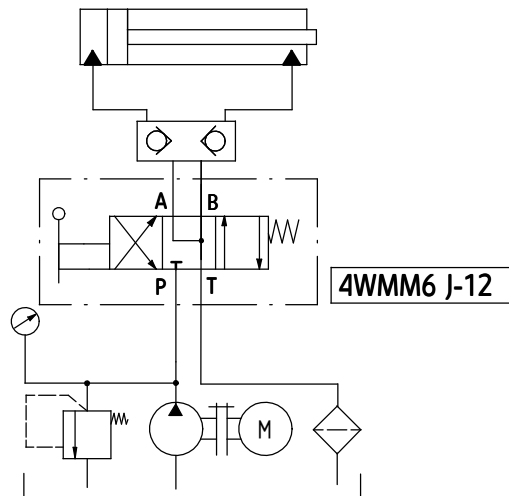

**Directional spool valve - hydraulically operated
 type WH6**

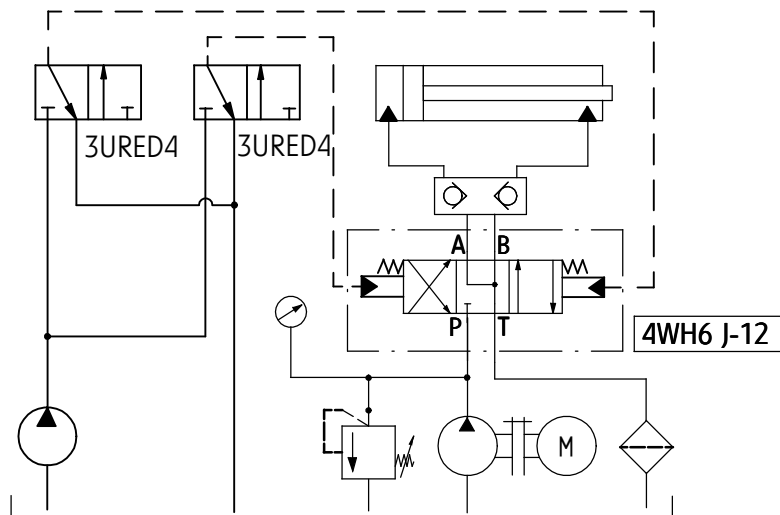

PONAR Wadowice S.A.
 ul. Wojska Polskiego 29
 34-100 Wadowice
 tel. +48 33 488 29 00
 fax. +48 33 488 21 03
www.ponar-wadowice.pl

PONAR[®]
 wadowice